

DV95 (PARTS AVAIL. SEPARATELY).

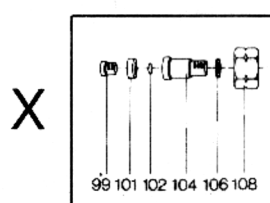

100 (COMPLETE ONLY).

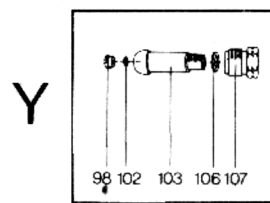
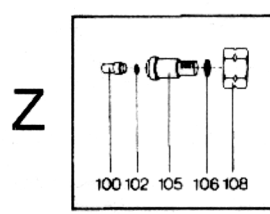
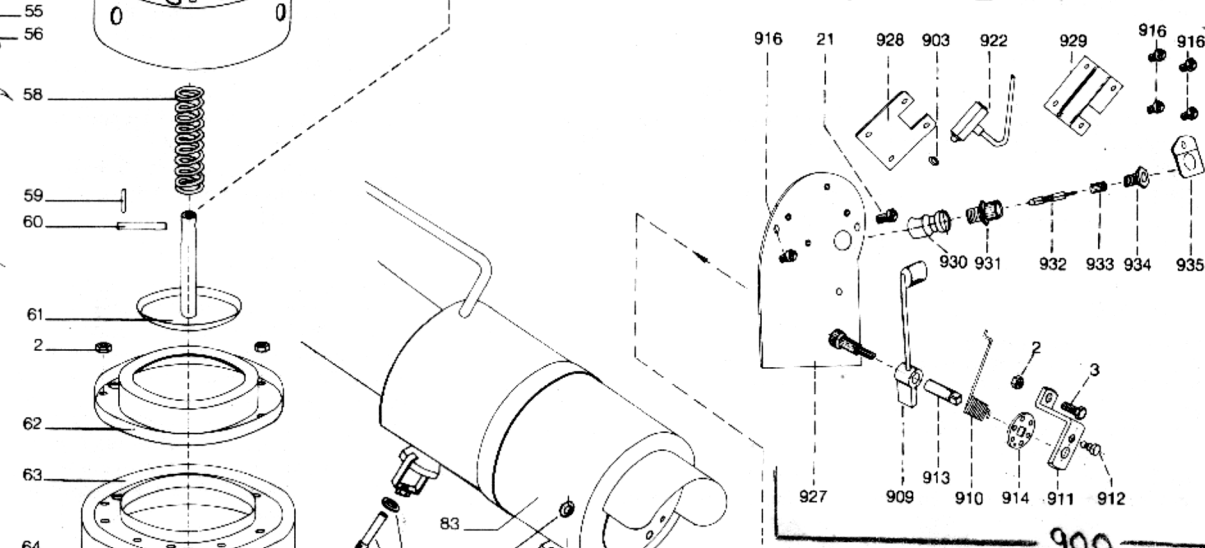
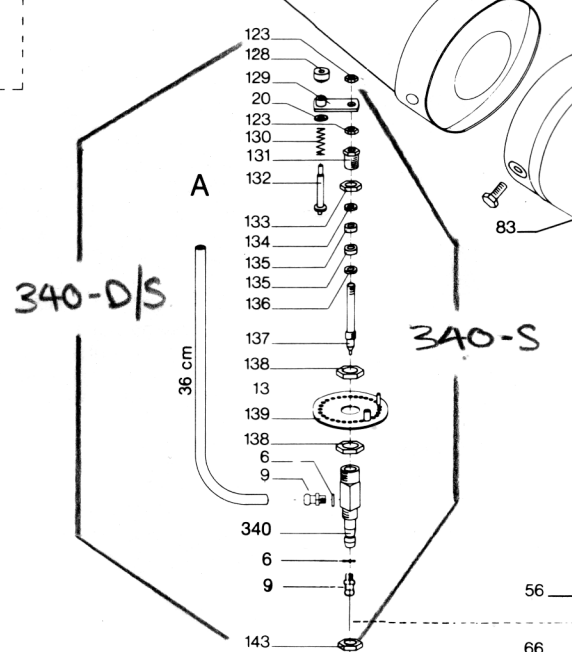
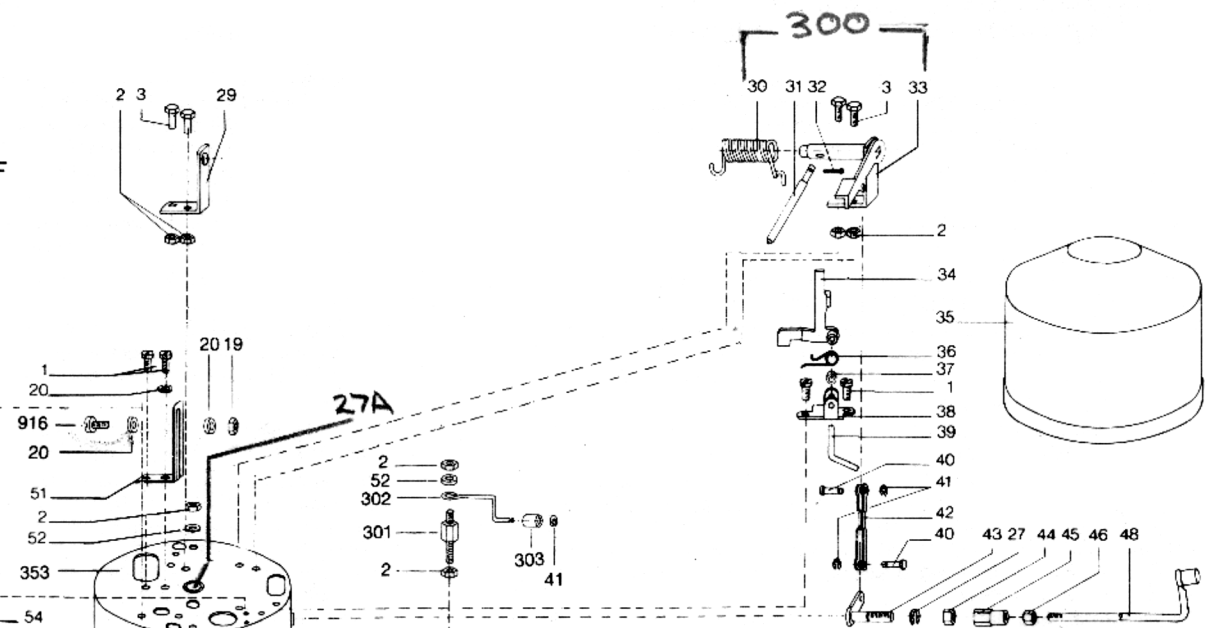
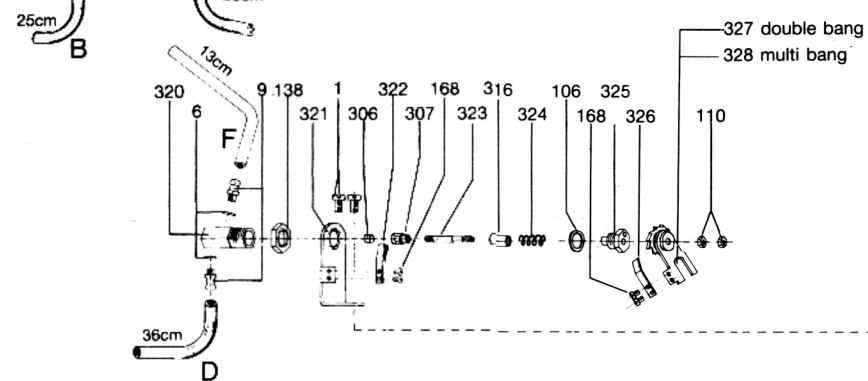
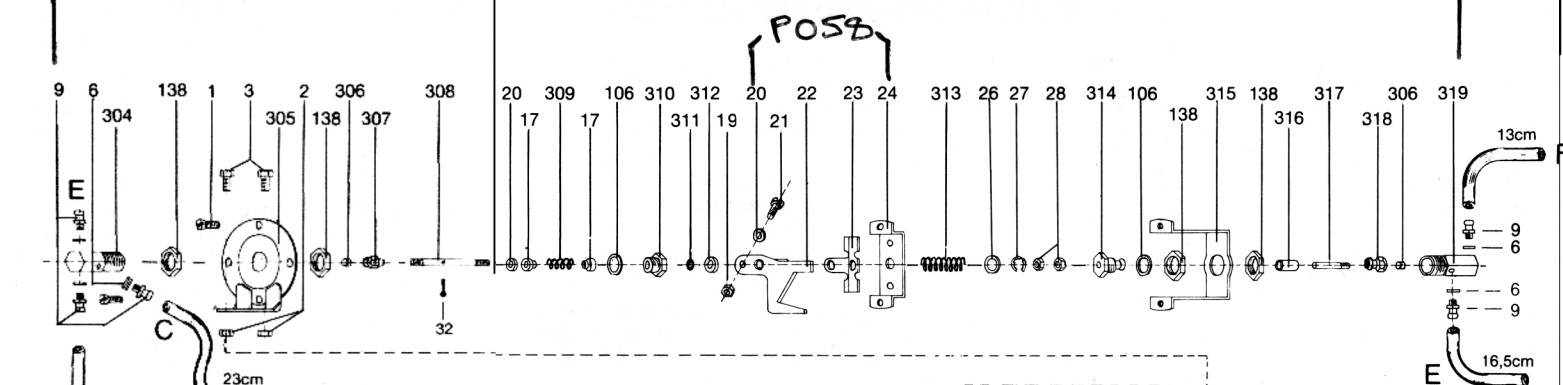
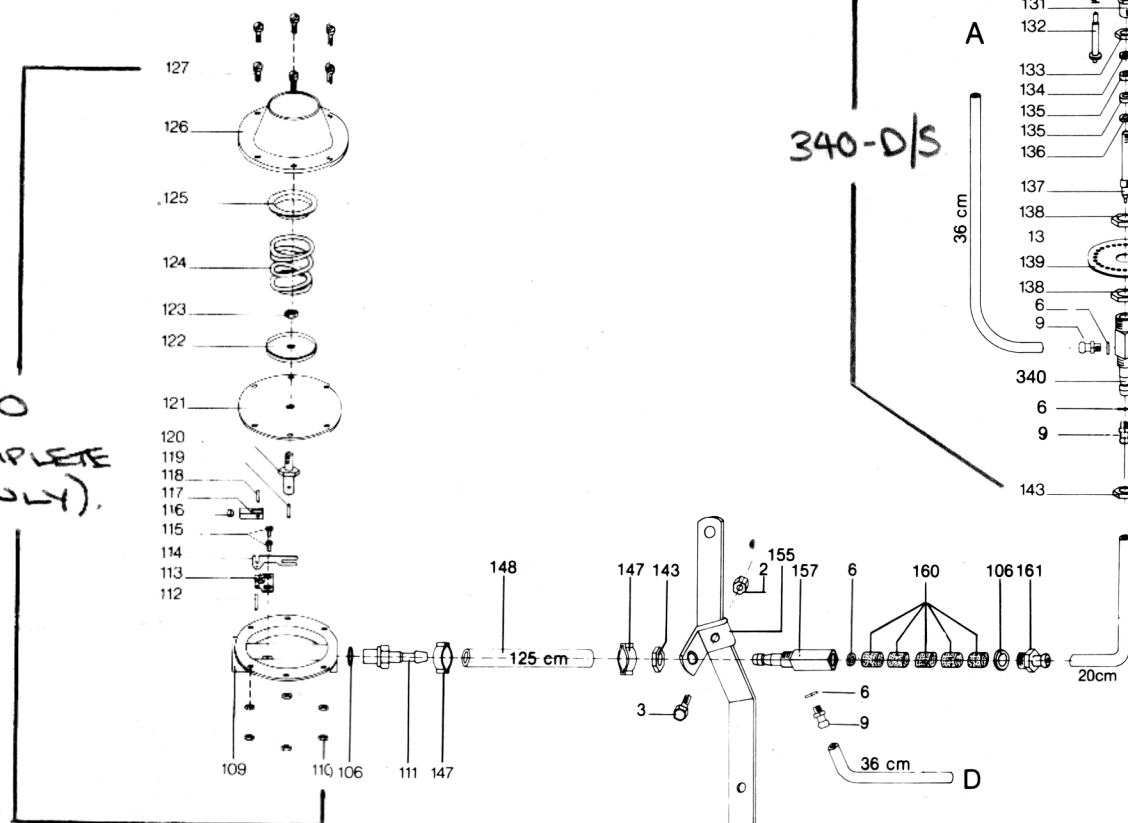

B83 - DOUBLE BANG  
B93 - MULTI BANG

